



Produktkatalog 2019
Product Catalogue 2019



Herausgeber Publisher

Adelmann GmbH
Wilhelm-Leonhard-Str. 5
77694 Kehl-Goldscheuer
Deutschland / Germany

Tel.: +49 (0)7854 / 98 339 - 0
Fax: +49 (0)7854 / 98 339 - 39
info@adelmann.net

Besuchen Sie uns im World Wide Web unter:

Visit us online:

www.adelmann.net

Gestaltung Design

kreativo Media, Web- und Werbeagentur
www.kreativo-media.de

Fotos Photos

Adelmann GmbH, shutterstock.com

Ausgabe Edition

Adelmann Produktkatalog 2019 © Copyright by Adelmann GmbH

Technische Änderungen und Druckfehler vorbehalten. The catalogue is subject to change, printing errors reserved.

Bildarstellungen können vom Original abweichen. Pictures can vary from the original product.

Stand aller Angaben: April 2019 | Status of Printing: April 2019

Über Adelman about us	4
Leistungen services	5
Produkte products	
 Schinkenformen ham moulds	6
 Sonderformen special moulds	18
 Lochblech- / Streckmetall-Formen - perforated sheet metal moulds - wireframe moulds	28
 Pastetenformen moulds for meat pies and loaves	32
 Wurstpressformen sausage-press moulds	36
 Leberkäsformen / Terrinenformen meat loaf moulds	40
 Hackfleischformen patty makers	44
Planung & Ersatz customized solutions & spare parts	48
Übersetzungen translations	49
Systematik der Formen-Herstellersnummer system for creating new manufacturer numbers	50



■ Geräte für die Lebensmittel- und Fleischwarenindustrie

Seit **fast einem Jahrhundert** ist ADELMANN national und international bekannt für die langlebige Qualität ihrer Schinken- und Pastetenformen sowie Hamburgerpressen aus Spezial-Aluminiumguss und aus rostfreiem Edelstahl.

Weit **über 500 unterschiedliche Modelle** werden bei ADELMANN im badischen Kehl-Goldscheuer gefertigt.

■ Formen nach Wunsch: Alles ist möglich - fragen Sie uns!

Zusätzlich zu den Basismodellen gestaltet ADELMANN mit modernster CAD-Technik auch Formen entsprechend individueller Kundenwünsche.

Fragen Sie uns, wir machen (fast) alles möglich!

■ Products in aluminium and stainless steel for the meat industry

Since **almost one century** the company name ADELMANN represents high quality products in special aluminium and stainless steel for the meat industry.

ADELMANN produces and distributes a wide range of ham moulds and paté/pastry moulds and many other different forms.

More than 500 different types are being produced at Adelman in Kehl-Goldscheuer (Germany).

■ Customized moulds: Everything is possible - just ask us!

Besides the mainstream models we use our profound knowledge combined with the latest CAD techniques to create customized moulds on request to our customers requirements worldwide.

Do not hesitate to send us yours!

■ ADELMANN Leistungsspektrum

- ADELMANN fertigt wahlweise in Aluminium und Edelstahl.
- Zu den Standardmodellen zählen eine Vielzahl von Schinkenkochern, Pastetenformen, Leberkäsformen, Wurstpressen, Hackfleischformen etc.
- Aluminiumformen sind sehr leicht und haben einen guten Wärmeübergang. Mit ihnen lassen sich auch komplexe Formen in kleineren Stückzahlen realisieren.
- Edelstahlformen sind pflegeleicht, resistent gegen Korrosion (z.B. durch Pökelsalze), lassen sich leicht reinigen und bleiben viele Jahre einsatzbereit. Eine sorgsame Endverarbeitung der Formen durch Glasperlenstrahlen oder elektropolierten Oberflächen sichern das Qualitätsniveau.

■ ADELMANN performance

- ADELMANN is manufacturing optionally in aluminium and stainless steel.
- A variety of basic models are e.g. ham moulds, pastry moulds, liver paté moulds, press moulds and hamburger presses.
- Aluminium moulds are known for lightweight and easy heat transmission.
- Stainless steel moulds are easy to clean and resistant to corrosion (caused by pickling salt) and can be used for many years. A very careful finish of the moulds by electropolishing or glass bead blasting ensures our well-known quality level.

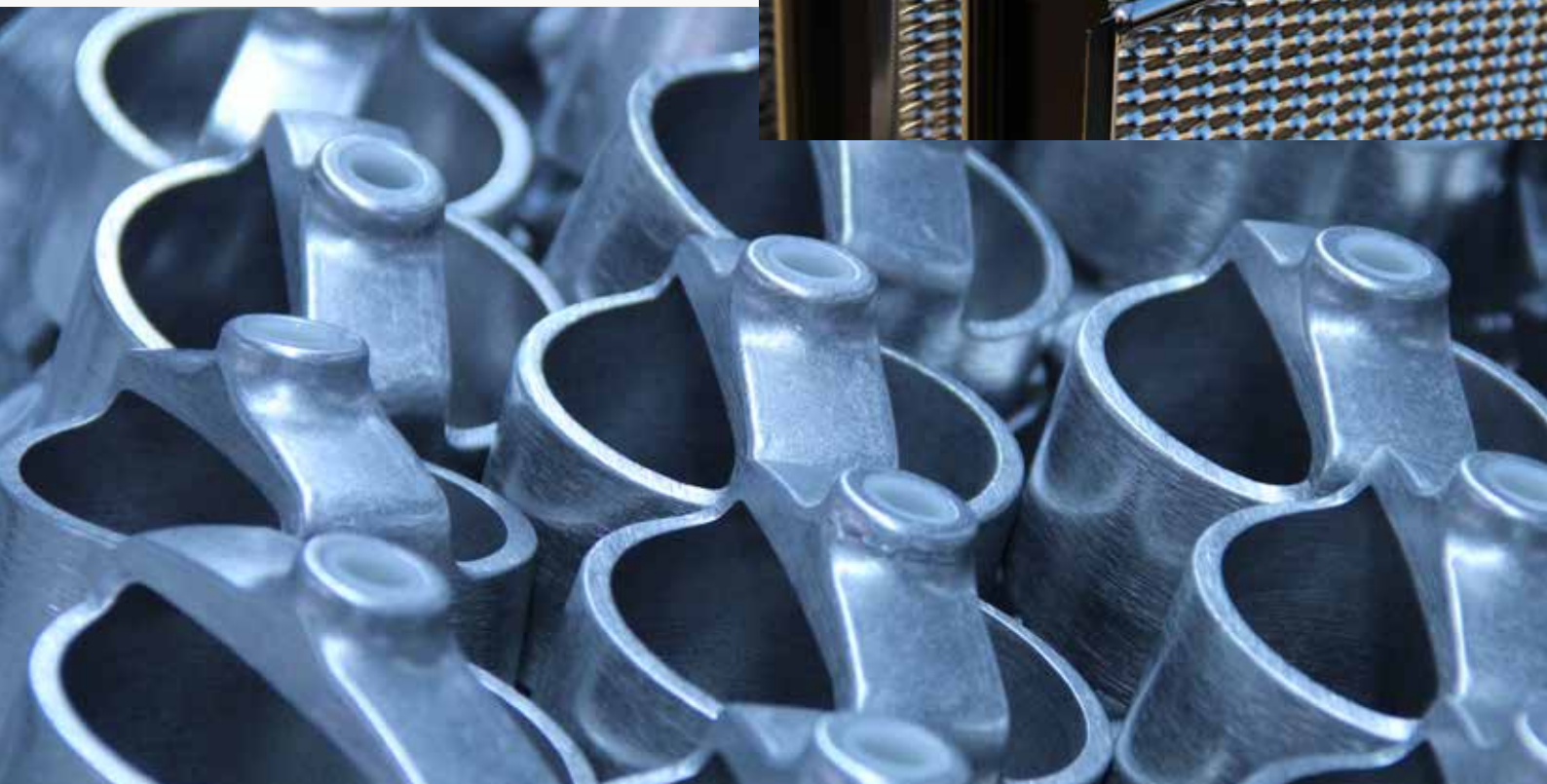
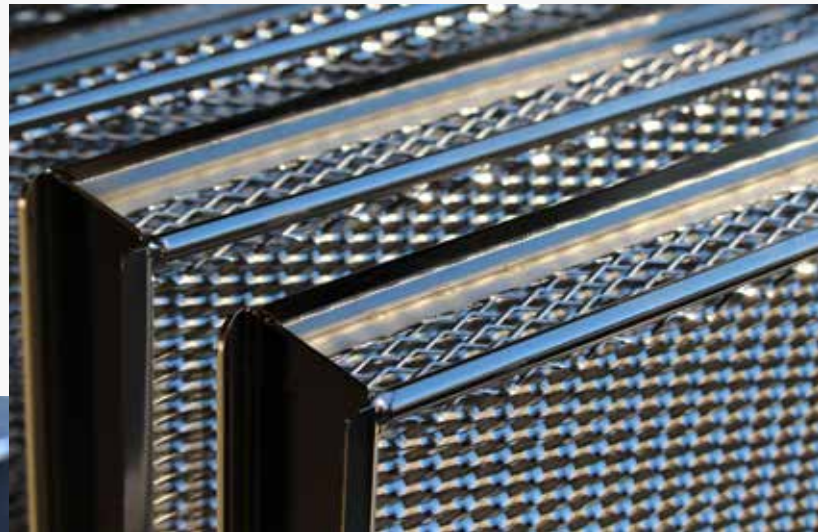

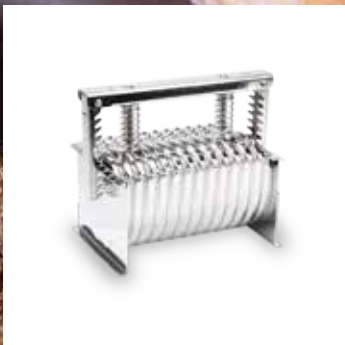

Schinkenformen

ham moulds

- Rechteckformen / rectangular moulds
- Bauchspeckform / bacon mould with dividing plates
- Tunnelform / tunnel shaped mould
- Rundform / round mould
- Rollform / mould for rolled ham with grooves
- Birnform / pear shaped mould

Schinkenformen

ham moulds

 Rechteckformen
rectangular moulds

Kapazität in kg capacity	Maße in mm (Innen- maße) inside dimensions			Artikel-ID Herstellernr.* item ID model	
	Länge length	Breite width	Höhe height	Aluminiumguss cast aluminium	Edelstahl geschweißt welded stainless steel
1,0	114	100	100	101710 00C	101711 00CNG
1,6	200	85	105	100013 00	105245 00NG
1,8	280	70	100	101657 RZ	113004 RZNG
2,0	240	95	105	101033 00G	111886 00GNG
2,0	180	110	120	101611 0W	104640 0WNG
2,4	300	90	100	101726 RP1 101261 RP1G ^[1]	103359 RP1NG
2,5	210	110	120	101612 00W	103277 00WNG
2,6	260	100	110	100599 RP0	101769 RP0NG
3,0	250	135	100	101034 014	105569 014NG
3,1	350	95	105	100601 RP2	108336 RP2NG
3,6	230	125	125	101613 0	103366 0NG
3,8	350	110	110	100565 RP24 111396 RP24G	108339 RP24NG
4,0	260	120	140	101413 02 101616 02G	104641 02NG
4,0	230	135	140	101614 1/2	108199 1/2NG
4,0	350	105	120	108337 RP22	108338 RP22NG

Kapazität in kg capacity	Maße in mm (Innenmaße) inside dimensions			Artikel-ID Herstellernr.* item ID model	
	Länge length	Breite width	Höhe height	Aluminiumguss cast aluminium	Edelstahl geschweißt welded stainless steel
4,4	245	150	130	101045 0G	107341 0GNG
4,4	506	93	105	101867 RP5	111017 RP5NG
4,5	290	120	140	101209 03	106437 03NG
4,5	270	140	130	101622 1 101054 1E 101625 1E-RI 101623 1G	101257 1NG 108866 1ENG
4,9	320	120	140	101617 04G	
4,9	245	135	160	109267 050	
5,0	320	120	140		106746 04NG 111015 04GNG
5,0	245	135	160		107340 050NG
5,2	220	180	140	100605 3/4	101044 3/4NG
5,3	305	140	135	102556 305	106826 305NG
5,4	260	160	140	101618 01 101619 01G	101224 01NG
5,4	270	160	135	101620 010	
5,5	275	160	135		111685 010NG

[1] mit geradem Deckel / with straight lid



* Ihre ist nicht dabei?

Stellen Sie Ihre eigene Form zusammen mit unserer Anleitung auf Seite 50

* You don't find yours?

Just create your own one with our manual on page 50

 **Rechteckformen**
rectangular moulds

Kapazität in kg capacity	Maße in mm (Innenmaße) inside dimensions			Artikel-ID Herstellernr.* item ID model	
	Länge length	Breite width	Höhe height	Aluminiumguss cast aluminium	Edelstahl geschweißt welded stainless steel
6,0	260	180	140	101621 011	102248 011NG
6,0	270	140	170	101579 1HG	
6,0	290	160	140	101423 2 100880 2E	100926 2NG 111014 2ENG
6,5	600	100	110		114752 RP6NG
6,5	270	205	120	101493 012	108283 012NG
6,5	700	95	105	101718 RP7	111136 RP7NG
7,0	420	150	120	101235 2L	108984 2LNG
7,7	900	90	105		125685 RP9331NG
8,0	310	180	150	101624 3 100606 3E	107125 3NG 108504 3ENG
8,0	400	180	120	101947 VE400	133491 VE400NG
8,5	500	120	140		111059 05NG
9,0	900	95	105	102324 RP9	
9,1	370	205	120	101048 013	111851 013NG
9,6	800	100	120		108389 RP8NG

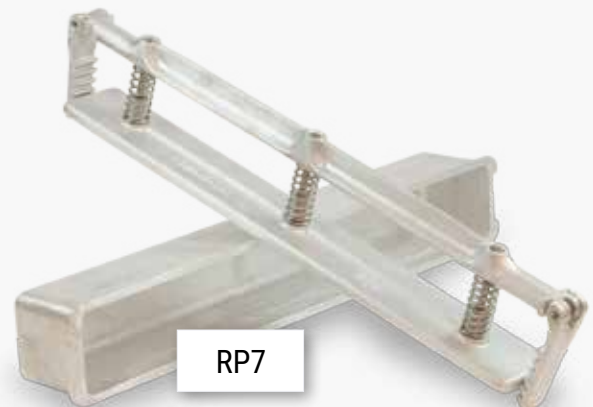

* Ihre ist nicht dabei?
Stellen Sie Ihre eigene Form zusammen mit unserer Anleitung auf Seite 50

* You don't find yours?
Just create your own one with our manual on page 50

Schinkenformen

ham moulds

 Rechteckformen
rectangular moulds

Kapazität in kg capacity	Maße in mm (Innenmaße) inside dimensions			Artikel-ID Hersteller.* item ID model	
	Länge length	Breite width	Höhe height	Aluminiumguss cast aluminium	Edelstahl geschweißt welded stainless steel
9,0	540	140	130		108630 12NG
9,0	900	105	105	111847 RP93	111848 RP93NG
9,0	900	100	110		102323 RP9NG
9,2	330	200	160		100576 4NG
9,5	570	140	130	101234 1L	108284 1LNG
10,0	330	200	160	101258 4	
10,0	330	200	160	100717 4E	101481 4ENG
10,2	500	185	120		102133 LK500 102327 LK502
10,9	700	120	140	107724 RP77	
10,9	900	115	115	113855 RP92	133456 RP92NG
11,0	490	200	125		131315 BE490NG
11,0	1000	110	110		115846 VE651
11,2	540	160	140		107930 22NG
11,3	450	180	150	102811 AL450	111846 AL450NG
11,5	1000	105	120		114581 RP931NG
12,0	500	200	130		111866 BE501NG
12,0	1000	100	120		122416 RP1000NG
13,0	340	200	200		123883 440NG
13,5	450	230	130		108785 FI450
13,5	400	225	160	104317 4LG	
13,7	700	135	155		125359 0141NG
14,5	400	225	160		107170 4LNG
17,0	950	190	104		108008 ME950 ^[1]
24,5	1000	180	145		118826 DE1000 ^[1]



RP9NG



BE490NG



12NG



RP77

[1] aus Lochblech

 Rechteckform, tiefgezogen
rectangular mould, deep drawn

Kapazität in kg capacity	Maße in mm (Innenmaße) inside dimensions			Artikel-ID Herstellernr.* item ID model
	Länge length	Breite width	Höhe height	Edelstahl tiefgezogen deep drawn stainless steel
3,0	225	120	120	102809 4300N 111138 4300EN
4,8	265	140	140	101013 4310N 108989 4310EN
5,0	300	145	125	152414 4304N 152421 4304EN
6,5	290	160	140	101042 2EN 101281 2N
7,8	308	180	150	101063 3EN
7,8	310	180	150	101273 3N



 Bauchspeckform, auch mit Trennplatten
bacon mould with dividing plates

Kapazität in kg capacity	Maße in mm (Innenmaße) inside dimensions			Artikel-ID Herstellernr.* item ID model
	Länge length	Breite width	Höhe height	Edelstahl geschweißt welded stainless steel
4,7	230	180	125	116404 BS230NG
5,5	420	190	70	125736 BS420NG
6,5	400	180	100	109917 SK400
6,7	480	200	80	124975 SK481
7,2	400	200	100	112843 BS400
7,2	450	200	90	124026 SK450
7,6	450	240	80	120567 BS453
8,0	450	170	115	105948 LK450
8,6	480	200	100	120999 BS480NG
9,1	440	180	125	116695 BS440
10,0	500	200	110	110327 BS500

Kapazität in kg capacity	Maße in mm (Innenmaße) inside dimensions			Artikel-ID Herstellernr.* item ID model
	Länge length	Breite width	Höhe height	Edelstahl geschweißt welded stainless steel
10,1	450	250	100	120993 BS454
10,8	450	200	130	112176 BS450
11,5	480	185	140	102555 SK480
11,8	450	175	160	114816 BS452/2
12,1	900	150	100	124395 BS900NG
12,5	500	250	100	132888 RE500250100NG
15,8	800	180	120	122837 BS820NG
21,0	500	300	150	125214 BS530NG
21,7	790	220	135	125387 BS790NG
23,0	800	230	135	120732 BS800

* Ihre ist nicht dabei?

Stellen Sie Ihre eigene Form zusammen mit unserer Anleitung auf Seite 50

* You don't find yours?

Just create your own one with our manual on page 50



Schinkenformen

ham moulds



Tunnel-Form, innen glatt
tunnel shaped mould, inside plain

Kapazität in kg capacity	Maße in mm (Innenmaße) inside dimensions			Artikel-ID Herstellernr.* item ID model	
	Länge length	Breite width	Höhe height	Aluminiumguss cast aluminium	Edelstahl geschweißt welded stainless steel
2,3	240	100	110	101353 69R	133243 69RNG
2,7	260	120	100	108683 850R	133247 850RNG
3,0	240	115	120	102319 67R	133244 67RNG
3,5	220	150	120	101863 612G	101445 612RNG
3,8	350	110	110	102608 6990R	133248 6990RNG
4,3	330	115	125	101865 690R	101765 690RNG
4,3	895	66	80	103276 910R	
4,3	900	66	80		133256 910RNG
4,4	440	100	110	102529 69LR	133252 69LRNG
4,5	790	75	85	109405 S790R	133253 S790RNG
5,0	250	170	140	103360 620G	101496 620RNG
6,0	900	97	80	107558 901R	133257 901RNG
6,3	800	100	90		132392 TU80010090NG
6,8	550	115	120	101866 690LR	133255 690LRNG
8,6	700	115	120		105337 6901RNG
10,0	800	115	120	101140 908	133258 908RNG
11,7	750	150	120		104035 6122RNG





Tunnelform gerillt
tunnel shaped mould with grooves

Kapazität in kg capacity	Maße in mm (Innenmaße) inside dimensions			Artikel-ID Herstellernr.* item ID model	
	Länge length	Breite width	Höhe height	Aluminiumguss cast aluminium	Edelstahl geschweißt welded stainless steel
2,3	220	140	100	101226 7115G ^[1]	133230 7115RNG
3,0	310	110	110	101926 70G ^[1]	106827 70RNG
3,4	220	150	130		122673 7140RNG
3,6	220	160	130	107150 7150G	102439 7150RNG 111402 7150RNG-OR ^[2]
4,4	450	110	110	107093 700G ^[1]	105311 700RNG
4,4	310	150	120		111837 701RNG
4,8	250	170	140	101035 720G ^[1]	104898 720RNG
4,9	350	150	120		126445 6125RGI ^[3]
5,0	270	170	140	111662 72G	
5,2	280	150	150		102890 AM280
5,3	310	150	140		117399 702RNG
5,3	400	140	120		144252 TUR400140NG
5,6	400	150	120		122874 701LRNG
6,4	450	150	120		103253 7011RNG
8,5	600	150	120		124876 7013RNG

^[1] Diese Formen haben einen flachen Deckel

^[2] Diese Form ist ohne Rand

^[3] aus Lochblech



7150RNG



7150G

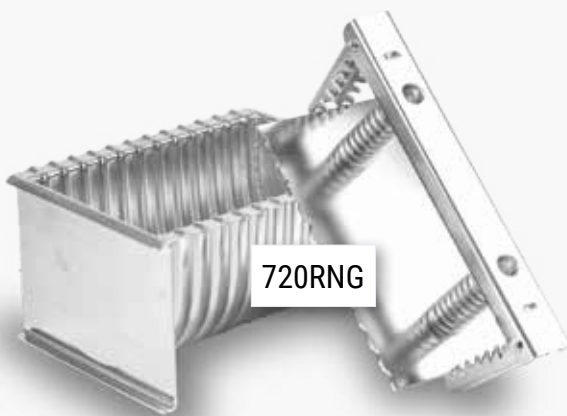

720RNG



700G

Schinkenformen

ham moulds



Rundform, innen glatt
round mould, inside plain

Kapazität in kg capacity	Maße in mm (Innenmaße) inside dimensions		Artikel-ID Herstellernr.* item ID model	
	Länge length	Durchmesser diameter	Aluminiumguss cast aluminium	Edelstahl geschweißt welded stainless steel
1,4	270	80	103704 SO270	133236 SO270NG
1,9	450	74	111143 65L	133260 65LNG
1,9	240	100	101391 69	133237 69NG
2,3	450	80	103035 68L	106003 80LNG
2,4	280	105	101390 660	133238 660NG
2,5	240	115	102326 67	133239 67NG
2,7	200	130	100911 608	132955 608NG
3,0	290	115	101528 680	133259 680NG
3,4	330	115	100531 690	102071 690NG
3,5	200	150	102318 610	123914 610NG
3,5	440	100	101134 69L	118340 69LNG
3,8	370	115		102217 6902NG
3,9	220	150	100904 612	103755 612NG
4,4	220	160	101495 615	103417 615NG
5,0	220	170		122747 616NG
5,3	300	150		130007 6126NG
5,5	270	160	101414 600 ^[1]	
5,7	250	170	101272 620	102005 620NG
5,7	600	110		113023 670NG
5,7	550	115	100760 690L	112321 690LNG
5,7	900	90		133069 RU9009090NG
6,5	500	130		124794 6081NG
6,5	920	95	111196 915	133269 915NG
6,6	500	130	102703 608L	133261 608LNG
6,8	700	111		126313 901NG
6,9	220	200		125706 642NG



67



620NG



600

praktische Trennplatte wird mitgeliefert



608NG



Rundform, innen glatt
round mould, inside plain

Kapazität in kg capacity	Maße in mm (Innenmaße) inside dimensions		Artikel-ID Herstellernr.* item ID model	
	Länge length	Durchmesser diameter	Aluminiumguss cast aluminium	Edelstahl geschweißt welded stainless steel
7,2	920	100		133270 920NG
7,3	700	115		101236 6901NG
7,5	950	100	101702 MI950	
7,6	300	180		124182 086NG
8,0	600	130		124772 6080NG
8,7	900	111	101868 900	133271 900NG
10,0	500	160		120048 650NG
11,9	675	150	101037 612L	133272 612LNG
12,6	400	200		130482 6421NG
13,2	580	170		119994 69251NG
13,3	1000	130		124866 6082NG
13,3	750	150		104899 6122NG
13,7	680	160	101038 615L	102299 615LNG
13,9	900	140		119545 9001NG
15,4	1000	140		113053 611NG
15,9	900	150		117118 KN901NG
17,1	800	165		122408 KN810NG
17,6	1000	150		121891 KN1001NG
20,4	800	180		125124 0861NG



Schinkenformen

ham moulds



Roll-Form, mit Rillen, gerade Stirnseiten
mould for rolled ham with grooves, flat endings

Kapazität in kg capacity	Maße in mm (Innenmaße) inside dimensions			Artikel-ID Herstellernr.* item ID model	
	Länge length	Breite width	Höhe height	Aluminiumguss cast aluminium	Edelstahl geschweißt welded stainless steel
3,0	310	110	110	101217 70	101840 70NG
3,4	220	140	140	101213 7115	133233 7115NG
3,5	200	150	150	100542 710	117657 710NG
3,9	220	150	150		101504 7140NG
4,3	450	110	110	100597 700	100759 700NG
4,4	220	160	160	100853 7150	101230 7150NG
5,0	250	160	160	101492 7120	101832 7120NG
5,5	310	150	150	101446 701	102070 701NG
5,7	250	170	170	100600 720	101205 720NG
7,0	400	150	150	102566 701L	102010 701LNG
8,0	450	150	150		102215 7011NG
8,8	310	190	155		100861 74NG
9,0	260	210	210	107851 730	
10,0	400	180	180	100533 085	



Rund-Form, mit Rillen, mit einer runden Stirnseite
round mould with grooves, with one round end

Kapazität in kg capacity	Maße in mm (Innenmaße) inside dimensions			Artikel-ID Herstellernr.* item ID model	
	Länge length	Breite width	Höhe height	Aluminiumguss cast aluminium	
4,0	230	150	150	101831 71	
5,0	250	160	160	100607 715	
6,1	270	170	170	101207 72	
8,8	310	190	190	101138 73 111145 73E	



* Ihre ist nicht dabei?

Stellen Sie Ihre eigene Form zusammen mit unserer Anleitung auf Seite 50

* You don't find yours?

Just create your own one with our manual on page 50



Birn-Form, runde Stirnseiten, nur in Aluminium
pear shaped mould, round endings, only in cast aluminium

Kapazität in kg capacity	Maße in mm (Innenmaße) inside dimensions			Artikel-ID Herstellernr.* item ID model
	Länge length	Breite width	Höhe height	Aluminiumguss cast aluminium
1,5	155	121	110	101626 00SB
2,0	180	130	110	101627 00B
2,0	188	142	90	103365 01S
3,5	235	160	130	100549 0SB
3,5	220	160	140	101628 0B
4,0	270	170	130	101280 1B 102785 1BE
4,5	250	180	160	101630 11B
6,0	290	190	140	101137 2B 101634 2BE
8,0	310	210	150	101631 3B 101635 3BE
10,0	330	230	160	101632 4B 101636 4BE



01S



4402BN



Birn-Form, runde Stirnseiten, tiefgezogen,
nur aus Edelstahl
pear shaped mould, round endings, deep
drawn, only stainless steel

Kapazität in kg capacity	Maße in mm (Innenmaße) inside dimensions			Artikel-ID Herstellernr.* item ID model
	Länge length	Breite width	Höhe height	Edelstahl tiefgezogen deep drawn stainless steel
1,0	155	110	100	101590 4410BN
3,0	225	170	125	101824 4411BN
4,5	258	175	130	102770 4413BN 109083 4413BEN
6,0	272	198	150	101259 4415BN 102151 4415BEN
7,0	310	220	130	114561 4417BN 113174 4417BEN



Birn-Form, gerade Stirnseiten, tiefgezogen,
nur aus Edelstahl
pear shaped mould, flat endings,
deep drawn, only stainless steel

Kapazität in kg capacity	Maße in mm (Innenmaße) inside dimensions			Artikel-ID Herstellernr.* item ID model
	Länge length	Breite width	Höhe height	Edelstahl tiefgezogen deep drawn stainless steel
4,0	245	192	135	102011 4401BN
4,5	262	185	132	152359 4403BN 152363 4403BEN
5,0	260	216	140	111838 4404BN 111840 4404BEN
6,0	275	200	150	101853 10BN 102152 10BEN
8,0	310	220	130	111839 4405BN 110856 4405BEN

* Ihre ist nicht dabei?

Stellen Sie Ihre eigene Form zusammen mit unserer Anleitung auf Seite 50

* You don't find yours?

Just create your own one with our manual on page 50

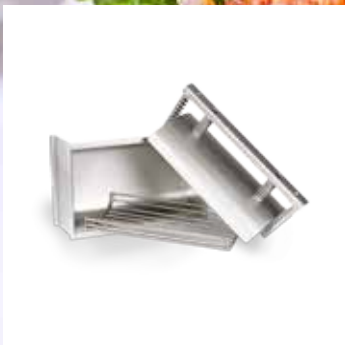

Sonderformen

special moulds

- Sülzkotelett-Form / mould for cutlet in aspic
- Wolken-Form / cloud shaped mould
- Eisbeinkocher / mould for pig's knuckles
- Melonen-Form / melon shaped mould
- Knochenschinken-Form / leg ham mould
- Parma-Form / leg ham mould
- Puten-Form / turkey-mould
- Laib-Form / loaf shaped mould
- Mandolinen-Form / mandoline shaped mould
- Schinken und Schwarte / ham and rind
- Herz-Form / heart shaped mould
- Tier-Formen / special moulds

Sonderformen

special moulds



Sülzkotelett-Form
mould for cutlet in aspic

Kapazität in kg capacity	Maße in mm (Innenmaße) inside dimensions			Artikel-ID Herstellernr.* item ID model	
	Länge length	Breite width	Höhe height	Aluminiumguss cast aluminium	Edelstahl geschweißt welded stainless steel
3,5 - 4,0	260	150	100	108085 KR26	
4,0 - 4,5	445	170	85	100852 692	100655 692NG
4,5	445	115	85	102871 697	
5,0	445	127	85	100661 691	102527 691NG
5,5	500	127	85		114034 6913NG
6,0	600	127	85	101651 691L	146991 691LNG
6,5	650	127	85		115824 6914NG
8,5	900	127	74		132044 SO90012774NG
9,0	900	127	85		107339 6912NG
9,0	900	107	120		108798 LA900NG
9,0	950	127	85		124510 6915NG



691



LA900

*** Ihre ist nicht dabei?**

Stellen Sie Ihre eigene Form zusammen mit unserer Anleitung auf Seite 50

*** You don't find yours?**

Just create your own one with our manual on page 50



Wolken-Form
cloud shaped mould

Kapazität in kg capacity	Maße in mm (Innenmaße) inside dimensions			Artikel-ID Herstellernr.* item ID model	
	Länge length	Breite width	Höhe height	Aluminiumguss cast aluminium	Edelstahl geschweißt welded stainless steel
3,0 - 4,0	250	150	110	100934 WO250	
4,0 - 4,5	440	100	105	101873 KR44	
4,0 - 5,0	250	160	130		113089 WO251NG
5,0 - 6,0	540	120	115	111844 KR54	
11,0 - 13,0	680	160	125		101448 WO680



Schinken-Form
ham mould

Kapazität in kg capacity	Maße in mm (Innenmaße) inside dimensions			Artikel-ID Herstellernr.* item ID model	
	Länge length	Breite width	Höhe height	Aluminiumguss cast aluminium	Edelstahl stainless steel
2,0 - 3,0	270	170	70	100648 6927	
4,0 - 5,0	230	200	135	106677 KR230	
6,0	500	150	80	101394 6950	
11,8	400	230	130		111227 K400
10,0 - 13,0	680	160	130	100923 693	
11,0 - 13,0	450	230	135	108547 K450	
22,0	800	230	135	103517 K800	



Sonderformen special moulds



Eisbeinkocher
mould for pig's knuckles

Kapazität in kg capacity	Maße in mm (Innenmaße) inside dimensions		Artikel-ID Herstellernr.* item ID model
	Breite width	Höhe height	
0,7 - 1,00	110	140	100907 63

63



Sonderform
mould

Kapazität in kg capacity	Maße in mm (Innenmaße) inside dimensions			Artikel-ID Herstellernr.* item ID model
	Länge length	Breite width	Höhe height	
2,0	190	150	100	101578 VE190

VE190



Melonen-Form
melon shaped mould

Kapazität in kg capacity	Maße in mm (Innenmaße) inside dimensions		Artikel-ID Herstellernr.* item ID model
	Breite width	Höhe height	
0,8 - 1,0	145	65	101215 39
1,8	155	70	101724 40
1,5 - 2,2	190	75	100847 42

39





Knochenschinken-Form
leg ham mould

Kapazität in kg capacity	Maße in mm (Innenmaße) inside dimensions			Artikel-ID Herstellernr.* item ID model	
	Länge length	Breite width	Höhe height	Aluminiumguss cast aluminium	
3,0 - 4,0	310	200	120	100612 ST310	



ST310



Parma-Form
leg ham mould

Kapazität in kg capacity	Maße in mm (Innenmaße) inside dimensions			Artikel-ID Herstellernr.* item ID model	
	Länge length	Breite width	Höhe height	Aluminiumguss cast aluminium	
5,0 - 7,0	325	265	105	100945 635PA	



635PA



Rouladen-Form, glatt
roulade mould, inside plain

Kapazität in kg capacity	Maße in mm (Innenmaße) inside dimensions			Artikel-ID Herstellernr.* item ID model	
	Länge length	Breite width	Höhe height	Aluminiumguss cast aluminium	Edelstahl geschweißt welded stainless steel
7,0 - 8,0	600	134	85	120259 694	102226 694NG
8,0 - 10,0	750	134	85		103516 6941NG



694



694NG

Sonderformen

special moulds



Laib-Form
loaf shaped mould

Kapazität in kg capacity	Maße in mm (Innenmaße) inside dimensions			Artikel-ID Herstellernr.* item ID model	
	Länge length	Breite width	Höhe height	Aluminiumguss cast aluminium	Edelstahl tiefgezogen deep drawn stainless steel
3,0	193	133	135	114610 623	
4,5	225	180	135		101229 4460N
5,0	263	150	145	114609 622	
5,5	315	190	115	101216 633	
6,0	235	210	150	100935 630 100611 630RI	112826 630N
7,0	290	225	140		102101 4461N



622



633



Mandolinen-Form
mandoline shaped mould

Kapazität in kg capacity	Maße in mm (Innenmaße) inside dimensions			Artikel-ID Herstellernr.* item ID model	
	Länge length	Breite width	Höhe height	Aluminiumguss cast aluminium	Edelstahl tiefgezogen deep drawn stainless steel
4,2	225	180	140	108429 M1	
5,5	248	194	150	102583 2M 104415 2MG	
5,8	220	175	150		102050 4470N
7,5	257	203	170		102051 4471N
7,5	280	224	160	104674 5M 111842 5MG	



4461N



5MG



4470N



Schinken und Schwarte
ham and rind

Kapazität in kg capacity	Maße in mm (Innenmaße) inside dimensions			Artikel-ID Herstellernr.* item ID model	
	Länge length	Breite width	Höhe height	Aluminiumguss cast aluminium	Edelstahl tiefgezogen deep drawn stainless steel
3,0 - 3,5	250	193	110	100985 634	
3,0 - 3,5	245	193	125		113091 634N
4,5 - 6,0	245	200	170	101260 JC1	
6,0	230	215	125		102536 H2KN



634



JC1



H2KN



Herz-Form
heart shaped mould

Kapazität in kg capacity	Maße in mm (Innenmaße) inside dimensions			Artikel-ID Herstellernr.* item ID model	
	Länge length	Breite width	Höhe height	Aluminiumguss cast aluminium	Edelstahl geschweißt welded stainless
1,5 -2,0	250	100	100	101855 HE250	
2,0	500	95	80		133495 HE90NG



HE250



HE90NG

*** Ihre ist nicht dabei?**

Stellen Sie Ihre eigene Form zusammen mit unserer Anleitung auf Seite 50

*** You don't find yours?**

Just create your own one with our manual on page 50

Sonderformen / Tierformen

special moulds



Schweinchen-Form pig shaped mould

Kapazität in kg capacity	Maße in mm (Innenmaße) inside dimensions			Artikel-ID Herstellernr.* item ID model	
	Länge length	Breite width	Höhe height	Aluminiumguss cast aluminium	
2,2	385	125	95	100984	CO



CO



Puten-Form Hähnchen-Form turkey-mould

Kapazität in kg capacity	Maße in mm (Innenmaße) inside dimensions			Artikel-ID Herstellernr.* item ID model	
	Länge length	Breite width	Höhe height	Aluminiumguss cast aluminium	Edelstahl tiefgezogen deep drawn stainless steel
1,5	180	140	110	100986	PU100
2,5 - 3,0	210	170	135	102532	PU101
3,0	203	144	129		152422 6010N
3,0 - 4,0	219	209	108		112760 6005N
4,0	260	185	145		102315 6100N
4,5	250	200	145		102552 6200N



6100N



6005N
Putenbrust



PU100





Hühnchen-Form
chicken mould

Kapazität in kg capacity	Maße in mm (Innenmaße) inside dimensions			Artikel-ID Herstellernr.* item ID model	
	Länge length	Breite width	Höhe height	Aluminiumguss cast aluminium	Edelstahl tiefgezogen deep drawn stainless steel
2 x 1,0	145	105	95		101135 6000N



6000N



6000N



Kaninchen-Form
rabbit mould

Kapazität in kg capacity	Maße in mm (Innenmaße) inside dimensions			Artikel-ID Herstellernr.* item ID model	
	Länge length	Breite width	Höhe height	Aluminiumguss cast aluminium	
1,5	255	110	120	103705 L5	



L5



L5

*** Ihre ist nicht dabei?**

Stellen Sie Ihre eigene Form zusammen mit unserer Anleitung auf Seite 50

*** You don't find yours?**

Just create your own one with our manual on page 50

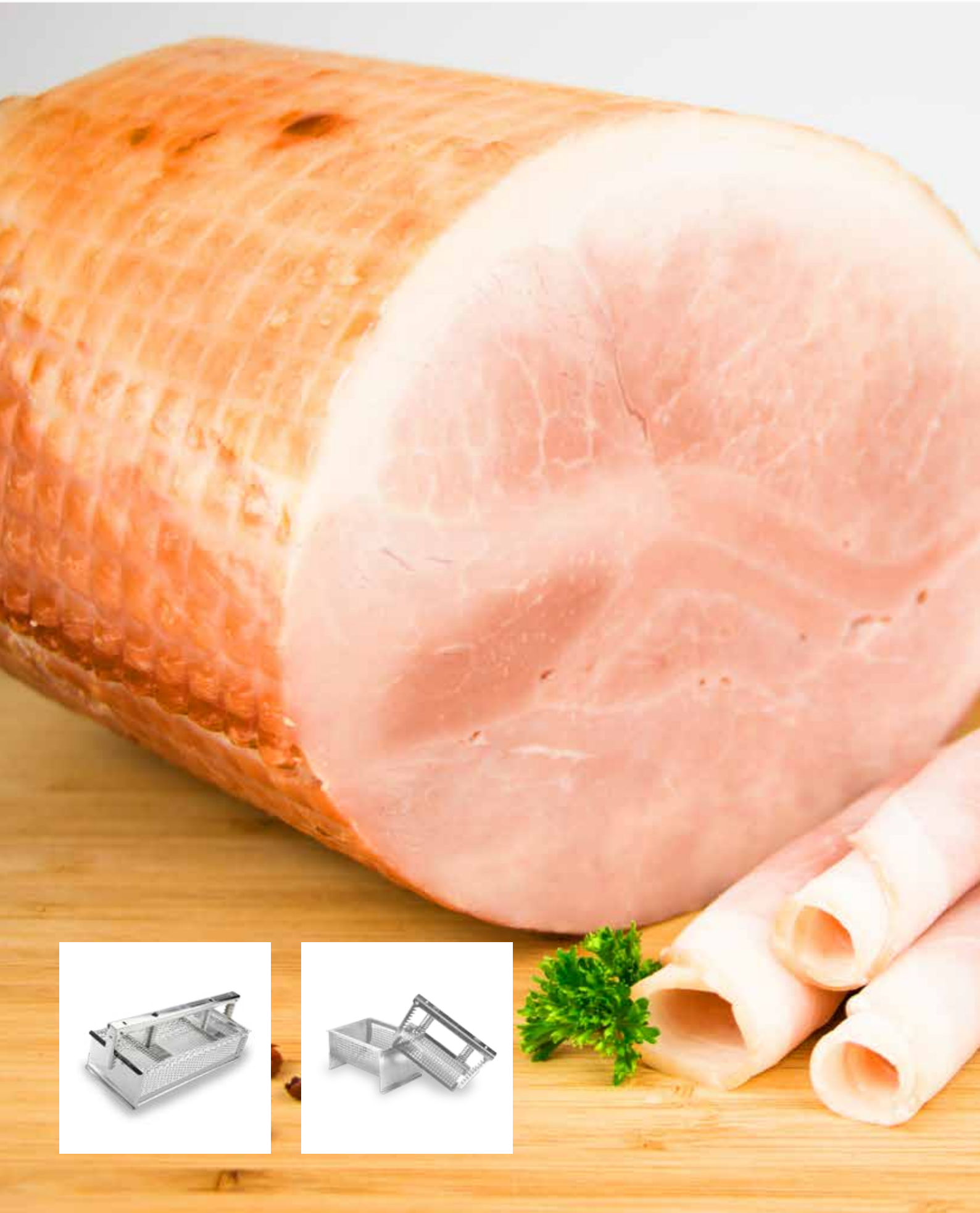

Lochblech- / Streckmetall-Formen

perforated sheet metal moulds / wireframe moulds

- Roastbeef-Form / mould for roast beef
- Lochblech-Form / perforated / punched metal mould
- Streckmetall-Form / expanded metal
- Drahtgitter-Form / wireframe

Lochblech- / Streckmetall-Formen

perforated/punched metal mould



Roastbeef-Form
mould for roast beef

Kapazität in kg capacity	Maße in mm (Innenmaße) inside dimensions			Artikel-ID Herstellernr.* item ID model	Querschnitt profile
	Länge length	Breite width	Höhe height	Edelstahl geschweißt welded stainless steel	
2,7	470	100	67	131217 RB470	
2,8	500	120	57	107843 RB500	
3,5	500	120	67	130066 RB501	
3,6	690	100	60	131219 RB690	

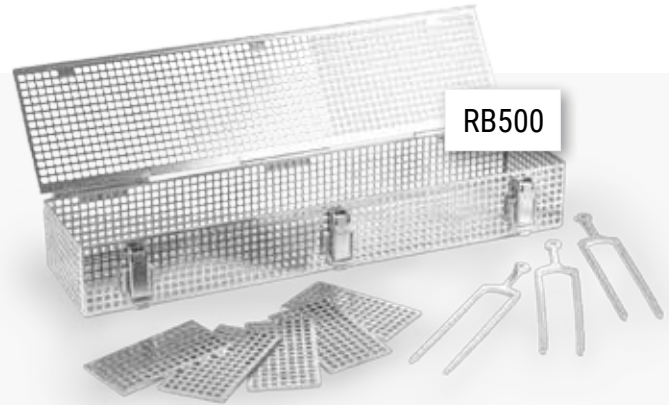

RB500



Lochblech-Form (rund, oval, rechteckig)
perforated / punched metal mould (round, oval, rectangular)

Kapazität in kg capacity	Maße in mm (Innenmaße) inside dimensions				Artikel-ID Herstellernr.* item ID model	Querschnitt profile
	Länge length	Durchmesser diameter	Breite width	Höhe height	Edelstahl geschweißt welded stainless steel	
2,1	220	110	-	-	113085 614GI	
3,5	450	100	-	-	121418 6770GI	
3,5	350	-	100	100	133055 WP1035L	
4,0	650	-	100	80	111487 KT651	
4,2	450	110	-	-	121290 675GI	
3,4	550	-	100	80	122175 KT550	
4,9	350	-	150	120	126445 6125RGI	
5,6	500	120	-	-	133313 RU500120LB	
5,6	250	170	-	-	102856 720GI	
7,0	900	100	-	-	112459 KT902NG	
7,3	330	-	170	140	115211 7201GI	
7,8	900	105	-	-	122420 6790GI	
11,3	1000	120	--	-	119020 DE1001	
17,0	950	-	190	104	108008 ME950	
24,5	1000	-	180	145	118826 DE1000	



675GI

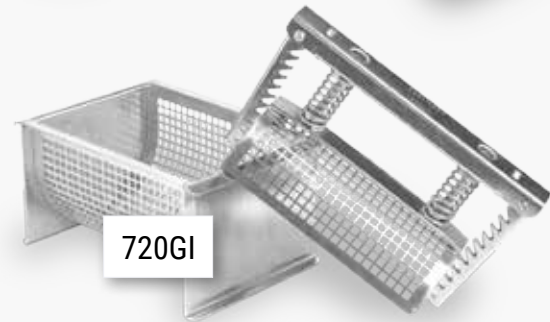

720GI



KT651



ME950



Streckmetall-Form
expanded metal

Kapazität in kg capacity	Maße in mm (Innenmaße) inside dimensions			Artikel-ID Herstellernr.* item ID model
	Länge length	Breite width	Höhe height	Edelstahl gestreckt expanded stainless steel
3,2	435	145	65	130980 BS435SM
4,3	546	105	85	125273 BS546SM
4,8	500	160	60	147182 BS50016060SM
5,0	450	160	60	132756 SO45016060SM
5,6	800	200	45	131823 BS801SM
5,7	470	110	120	117442 BS4701NG
6,2	480	185	80	132754 BS48018580SM
6,8	1000	80	95	133392 RE10008095SM
7,0	500	170	110	133496 OV500170110SM
7,8	480	180	100	122770 BS500SM



BS500SM



BS546SM

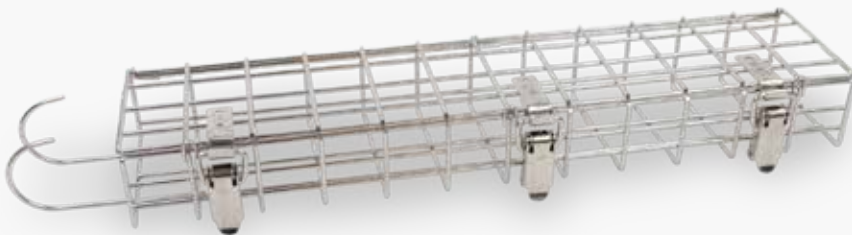

Drahtgitter-Form
wireframe

Kapazität in kg capacity	Maße in mm (Innenmaße) inside dimensions		Artikel-ID Herstellernr.* item ID model
	Länge length	Durchmesser diameter	Edelstahl geschweißt welded stainless steel
4,5 - 6,0	250	170	101208 720DNG



720DNG

* Ihre ist nicht dabei?
Stellen Sie Ihre eigene Form zusammen mit unserer Anleitung auf Seite 50

* You don't find yours?
Just create your own one with our manual on page 50



Pastetenformen

moulds for meat pies and loaves

- Rechteck-Form / rectangular mould
- Rund-Form / round mould
- Dreieck-Form / triangle shaped mould
- Tunnel-Form / tunnel shaped mould
- Pasteten-Form mit Schnappverschluss / pastry mould with snap fit

Pastetenformen

moulds for meat pies

 Rechteck-Form
rectangular mould

Kapazität in kg capacity	Maße in mm (Innenmaße) inside dimensions			Artikel-ID Herstellernr.* item ID model	
	Länge length	Breite width	Höhe height	Aluminiumguss cast aluminium	Edelstahl geschweißt welded stainless steel
0,6	240	55	75	100749 6P	
1,3	200	80	80	100972 1P	
1,6	250	80	80	100971 11/2P	
2,0	200	100	110		114562 P20N
2,5	250	100	110	100951 2P	102622 P25N
3,0	300	100	110	100530 3P	103989 P30N
4,5	500	90	100	126079 BG500	



 Rund-Form
round mould

Kapazität in kg capacity	Maße in mm (Innenmaße) inside dimensions			Artikel-ID Herstellernr.* item ID model	
	Länge length	Breite width	Höhe height	Aluminiumguss cast aluminium	Edelstahl geschweißt welded stainless steel
0,6	240	55	-	101026 6RD 101026 61RD	
1,2	250	80	-	101652 11/2RD	
1,4	400	66	80	108982 4RD	
2,0	250	100	100	100653 2RD	122931 2RDNG
2,6	300	100	-	101653 3RD	
3,3	400	100	-	102325 44RD	

 Dreieck-Form
triangle shaped mould

Kapazität in kg capacity	Maße in mm (Innenmaße) inside dimensions			Artikel-ID Herstellernr.* item ID model	
	Länge length	Breite width	Höhe height	Aluminiumguss cast aluminium	Edelstahl geschweißt welded stainless steel
1,2	400	73	82	100982 1 1/2V	



* Ihre ist nicht dabei?
Stellen Sie Ihre eigene Form zusammen mit unserer
Anleitung auf Seite 50

* You don't find yours?
Just create your own one with our manual on page 50

 **Tunnel-Form**
tunnel shaped mould

Kapazität in kg capacity	Maße in mm (Innenmaße) inside dimensions			Artikel-ID Herstellernr.* item ID model	
	Länge length	Breite width	Höhe height	Aluminiumguss cast aluminium	Edelstahl geschweißt welded stainless steel
0,7	240	55	75	100976 6R	
1,0	200	66	75	100974 5R	
1,2	200	80	80	100973 1R	
1,5	250	80	80	100652 11/2R	
2,0	400	66	80	100978 4R	
2,3	250	100	100	100608 2R	126852 2RNG
2,3	248	90	103	103795 45R	
2,7	300	100	100	101020 3R	126184 3RNG
3,6	400	100	100	103263 44R	



 **Pasteten-Form mit Schnappverschluss**
pastry mould with snap fit, rectangular

Kapazität in kg capacity	Maße in mm (Innenmaße) inside dimensions			Artikel-ID Herstellernr.* item ID model	
	Länge length	Breite width	Höhe height	Edelstahl geschweißt welded stainless steel	
2,5	250	100	100	101036 PS25N	
3,0	300	100	100	101055 PS30N	
3,5	350	100	100	100718 PS35N	
5,0	500	100	100	111900 PS50N	

Diese Maße können individuellen Kundenwünschen angepasst werden.
Various dimensions are available upon request.



 **Kochform für Leberpasteten**
cooking mould für liver paté

Kapazität in kg capacity	Maße in mm (Innenmaße) inside dimensions			Artikel-ID Herstellernr.* item ID model	
	Länge length	Breite width	Höhe height	Aluminiumguss cast aluminium	
1,25	280	75	65	100750 FP5	inkl. Gummidichtung (Siehe Abbildung rechts)







Wurstpressformen sausage-press moulds

- Wurstpress-Form / sausage press
- Vierkant-Pressform mit Stegeinsatz / square sausage press with dividing plates

Wurstpress-Formen

sausage moulds

 Wurstpress-Form
sausage press

Kapazität in kg capacity	Maße in mm (Innenmaße) inside dimensions			Artikel-ID Herstellernr.* item ID model
	Länge length	Breite width	Höhe height	Edelstahl geschweißt welded stainless steel
2,5	350	85	85	113057 WP8535
2,8	350	90	90	112510 WP9035
3,5	350	100	100	100578 WP1035
3,5	350	100	100	133055 WP1035L ^[1]
4,5	450	100	100	102595 WP1045
5,0	350	120	120	112550 WP1235
8,1	1000	90	90	113269 WP9010
10,0	1000	100	100	101256 WP1010



Diese Maße können individuellen Kundenwünschen angepasst werden.
Various dimensions are available upon request.

^[1] aus Lochblech

* Ihre ist nicht dabei?
Stellen Sie Ihre eigene Form zusammen mit unserer Anleitung auf Seite 50

* You don't find yours?
Just create your own one with our manual on page 50

 Vierkant-Pressform mit Stegeinsatz
square sausage press with diving plates

Kapazität in kg capacity	Maße in mm (Innenmaße) inside dimensions			Artikel-ID Hersteller.* item ID model
	Länge length	Breite width	Höhe height	Aluminiumguss cast aluminium
Gesamtkapazität der Form: 12,0	350	200	240	101043 WP350-4
Einzelkapazität der Form: 4 x 3 kg	350	100	100	







Leberkäsformen / Terrinenformen

meat loaf moulds

- Leberkäs-Formen / meat loaf moulds
- Terrinen-Formen / moulds for meat pies

Leberkäsformen

meat loaf moulds

 Leberkäs-Form
meat loaf mould

Kapazität in kg capacity	Maße in mm (Innenmaße) inside dimensions			Artikel-ID Herstellernr.* item ID model	
	Länge length	Breite width	Höhe height	Edelstahl geschweißt welded stainless steel	Edelstahl tiefgezogen deep drawn stainless steel
1,0	200	90	70	133361 LE2009070NG	
1,5	235	110	70	133360 LE23511070NG	
2,0	250	110	90	133359 LE25011090NG	
2,5	300	110	90		151430 LE300
3,2	300	140	90		101505 LE310
3,7	350	140	90		100988 LE350
5,3	500	140	90	124744 LE504NG	
10,0	950	140	90	121827 LE950NG	

Gerne fertigen wir Ihr Wunschmaß, fragen Sie uns an.
On request we are able to produce also customized sizes (only welded stainless steel).

















Auf Anfrage auch mit Anti-Haft-Beschichtung
On request also with non-stick coating



Terrinenformen

moulds for meat pies

 Terrinen-Form
mould for meat pies

Kapazität in kg capacity	Maße in mm (Innenmaße) inside dimensions			Artikel-ID Herstellernr.* item ID model	Formskizze mould sketch
	Länge length	Breite width	Höhe height	Edelstahl geschweißt welded stainless steel	
0,19	300	40	30	151559 PA411	
0,4	300	60	40	101025 PA410	
0,6	300	30-50	50	101750 PA210	
0,7	300	50	50	101607 PA350	
0,75	300	50	50	101022 PA120	
0,75	300	80	60	151462 PA415	
0,8	300	35-60	55	102855 PA241	
0,9	300	80	60	152243 PA420	
1,0	300	40-70	60	101251 PA230	
1,0	300	60	60	104052 PA360	
1,0	300	50 - 80	60	151551 PA130	
1,1	450	35-60	55	101252 PA240	
1,2	300	50-80	60	151551 PA246	

Alle Formen sind mit Deckel lieferbar. Lid available upon request.







Hackfleischformen

patty makers

Burgerpressen

patty makers

Hackfleisch-Former

patty makers







Kapazität in g capacity	Form shape	Maße in mm (Innenmaße) inside dimensions		Artikel-ID Herstellernr.* item ID model			
		Durchmesser diameter	Höhe height	Aluminium aluminium	Edelstahl / stainless steel mit glatter Druckplatte with smooth plate	Edelstahl / stainless steel mit strukturierter Druckplatte with structured plate	beschichtet coated
40		50	28		136766 AP50	146922 AP50S	
60		60	28		136769 AP60	146921 AP60S	
80		70	28		137900 AP70	146920 AP70S	
90		75	35	126710 KD11			141573 KD11B
110		85	28		134438 AP85	146919 AP85S	
120		90	40	100609 KD1			141544 KD1B
160		100	40	100805 KD2	146201 AP100		141545 KD2B
190		110	32		138290 AP110	141670 AP110S	
250		125	35	100610 KD4		133221 AP125	141335 KD4B
310		140	32		140023 AP140		
350		150	40	123234 KD9		142555 AP150S	141571 KD9B
400		160	32		141481 AP160		

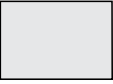

* Sondergrößen auf Anfrage

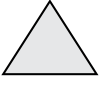
Beispiel für strukturierte Edelstahl-Druckplatte

Hackfleisch-Form
patty makers

Kapazität in g capacity	Form shape	Maße in mm (Innenmaße) inside dimensions			Artikel-ID Herstellernr.* item ID model	
		Länge length	Breite width	Höhe height	Aluminium aluminium	Edelstahl / stainless steel mit glatter Druckplatte with smooth plate
160		85	95	30	100804 KD3	
80		100	40	38		149899 AP100-40R ^[1]
160		90	90	32		136913 AP90R ^[1]
290		120	120	30	125407 KD10	
100		100	100	32	138475 KD12	138432 AP100D ^[1]
140		105	75	27	101228 KD5	
130		110	95	28	102534 KD6	
100		91	68	23	117680 KD8	
100		100	85	30	114494 KD7	

^[1] Diese Pressen gibt es auch mit einer strukturierten Druckplatte



Planung & Ersatz

customized solutions & spare parts

Bei einer Bestellung benötigen wir grundsätzlich die Angabe der hier abgebildeten Nummer zusammen mit der Materialangabe (Edelstahl oder Aluminium).

When ordering, we generally require the indication of the number shown here together with the material specification (stainless steel or aluminum).

Edelstahl
stainless steel

Aluminium
cast aluminium

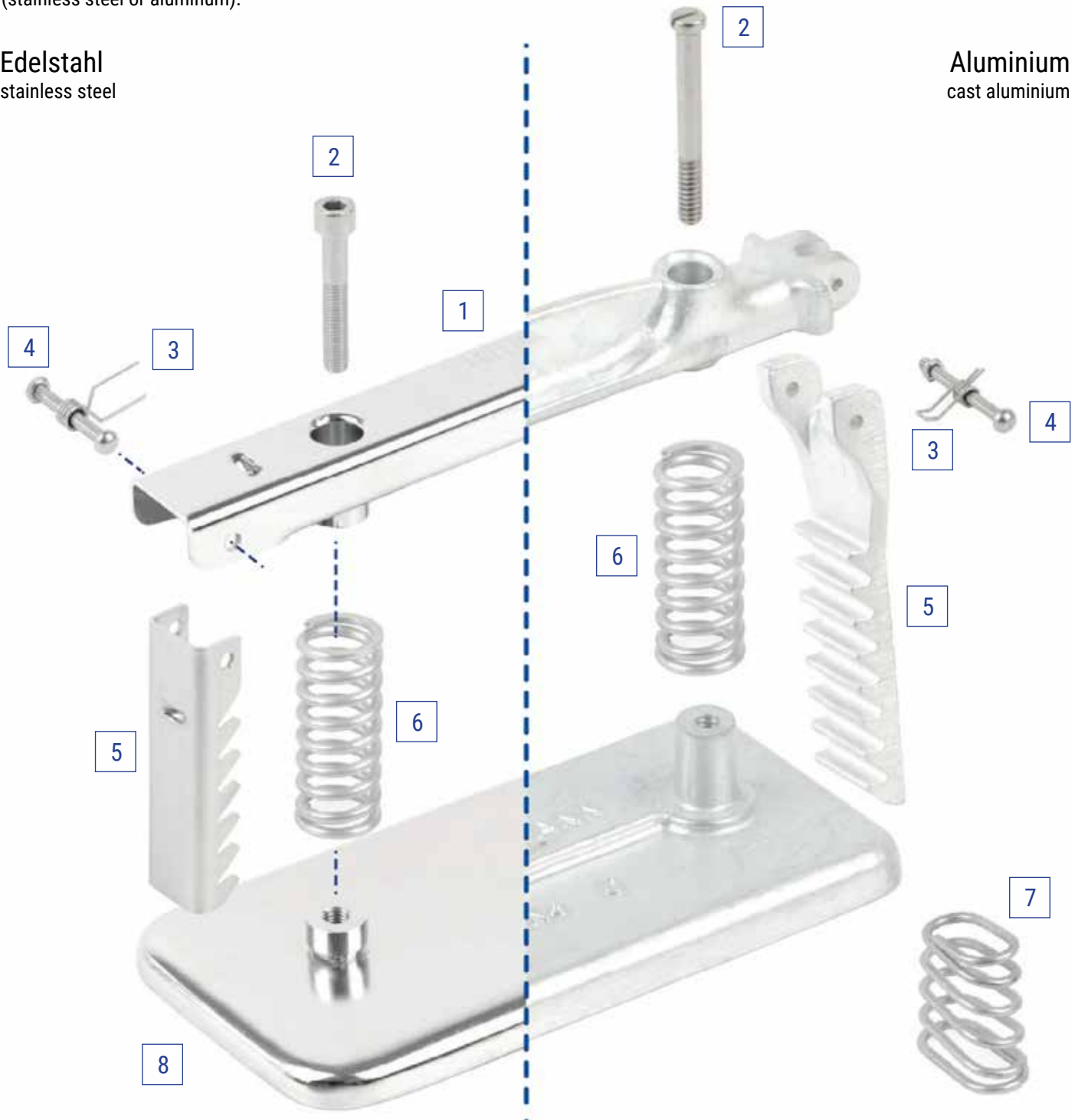

1 Bügel / handle

2 Deckelschraube / lid screw

3 Doppelschenkelfeder / double leg spring

4 Schraube mit Mutter / screw with nut

5 Zahnfalle / tooth lock

6 Deckelfeder / lid spring

7 Deckelfeder oval / lid spring oval

8 Deckel / lid

deutsch	english	français	español
Kapazität	capacity	contenance	capacidad
Bauchspeck	bacon mould	moule à bacon	molde bacon
Breite	width	largeur	anchura
Deckelunterseite flach	flat cover	couvercle plat	tapadera plana
Durchmesser	diameter	diamètre	diámetro
Edelstahl	stainless steel	acier inoxydable	acero inoxidable
Eisbeinkocher	mould for pig's knuckles	moule à jambonneaux	moldes pata de cerdo
Hackfleisch-Former	hamburger press	presse à Hamburger	moldear hamburguesas
halbrund, gerader Deckel	half-round, flat cover	semi-ronde, couvercle plat	semirondo, tapa derecha
Gitterform	lattice mould	moule à jambon grillé	molde enrejado
Herzform	heart-shaped mould	moule à coeur	molde corazón
Hühnchenform	chicken-mould	moule poulet double	molde pollo
Höhe	height	hauteur	altura
innen glatt	inside plain	intérieur lisse	interior liso
Innenmaße	inside dimensions	dimensions intérieures	medidas interiores
Kaninchen	rabbit-mould	moule à lapin	molde conejo
Länge	length	longueur	longitud
Melonenform	melon-shape mould	moule à melon	molde melon
Pasteten- und Rouladenform	moulds for meat pies and loaves	moules pour pâtés et roulades	moldes para paté y embutidos
Putenform	turkey mould	moule à dinde	molde pavo
Rautenmuster mit Deckel	rhombic design in cover	couvercle à relief	dibujo de rombo en tapadera
Rautenmuster in Deckel und Wanne	rhombic design in cover and tub	couvercle à relief et cuve	dibujo de rombo en tapad. y tina
Rechteckform	rectangular mould	moule rectangulaire	molde rectangular
Rollform	mould for rolled ham	moule pour jambon roulé	molde pare jamón arrolable
Rouladenpresse	mould for rolled meat	moule pour viande roulé	prensa para carne arrollada
Runder Deckel	round cover	couvercle ronde	tapadero redondo
Schinkenkocher	ham-press, ham-boiler	moules à jambon	moldes para jamón
Schweinchenform	pig-shaped mould	moule à cochon	molde cerdo
Sonderformen	special designed moulds	moule à forme spéciale	moldes especiales
Stirnseiten gerade	flat endings	à flanc droit	frente recta
tiefgezogen	deep drawn	moule formé pour emboutissage	moldes ebutidos a profund
Wolkenform	cloud-shaped mould	moule-nuage	molde nubes
Wurstpressform	sausage-press mould	moule à saucisse pressée	molde embutidos prensados

Herstellernummern

model numbers

Systematik der Formen - Herstellernummern

system for creating new manufacturer numbers

Beispiel: Sie benötigen eine Form aus Edelstahl geschweißt, rechteckig mit folgenden Maßen:

Länge: 400 mm **Breite:** 80 mm **Höhe:** 90 mm

Daher setzt sich die Herstellernummer wie folgt zusammen:

RE (für rechteckig) + 400 (Länge) + 80 (= Breite) + 90 (= Höhe) + NG (Edelstahl geschweißt)

Example: You need a form of stainless steel welded, rectangular with the following dimensions:

Length: 400 mm **Width:** 80 mm **Height:** 90 mm

Therefore, the manufacturer number is composed as follows:

RE (for rectangular) + 400 (length) + 80 (= width) + 90 (= height) + NG (welded stainless steel)

RE4008090NG

Eine Form besteht aus maximal 6 definierten Positionen:
One mould consists of a maximum of 6 defined positions:

1		2	3	4	5		6	
Formtyp / shape		Länge length	Breite width	Höhe oder Ø height or Ø	Ausführung / type		Material / material	
RE	rechteckig rectangular				RI	Mit Rillen with grooves	NG	Edelstahl geschweißt stainless steel, welded
RU	rund / round				LB	Lochblechform (Gi) perforated sheet metal (Gi)		
WP	Wurstpressform sausage press				WG	Wellengitter wire (wave shaped)	A	Aluminium cast aluminium
WO	Wolkenform cloud shaped				DRG	Drahtgitterform (DNG) wire frame mould		
TU	Tunnelform tunnel shaped				SM	Streckmetall expanded sheet metal	N	Edelstahl tiefgezogen stainless steel, deep drawn
RB	Roastbeefform roastbeef				RA	Mit Rauten with rhombus		
BI	Birnform pear shaped				T	Tunnel / tunnel		
SO	Sonderformen special				Q	Quadratisch / square		
TF	Tierformen animal shape				R	Rund / round		
LE	Leberkäsform meat loaf moulds				D	Dreieck / triangle		
KD	Hackfleischform patty maker							
PA	Pastetenform mould for paté							

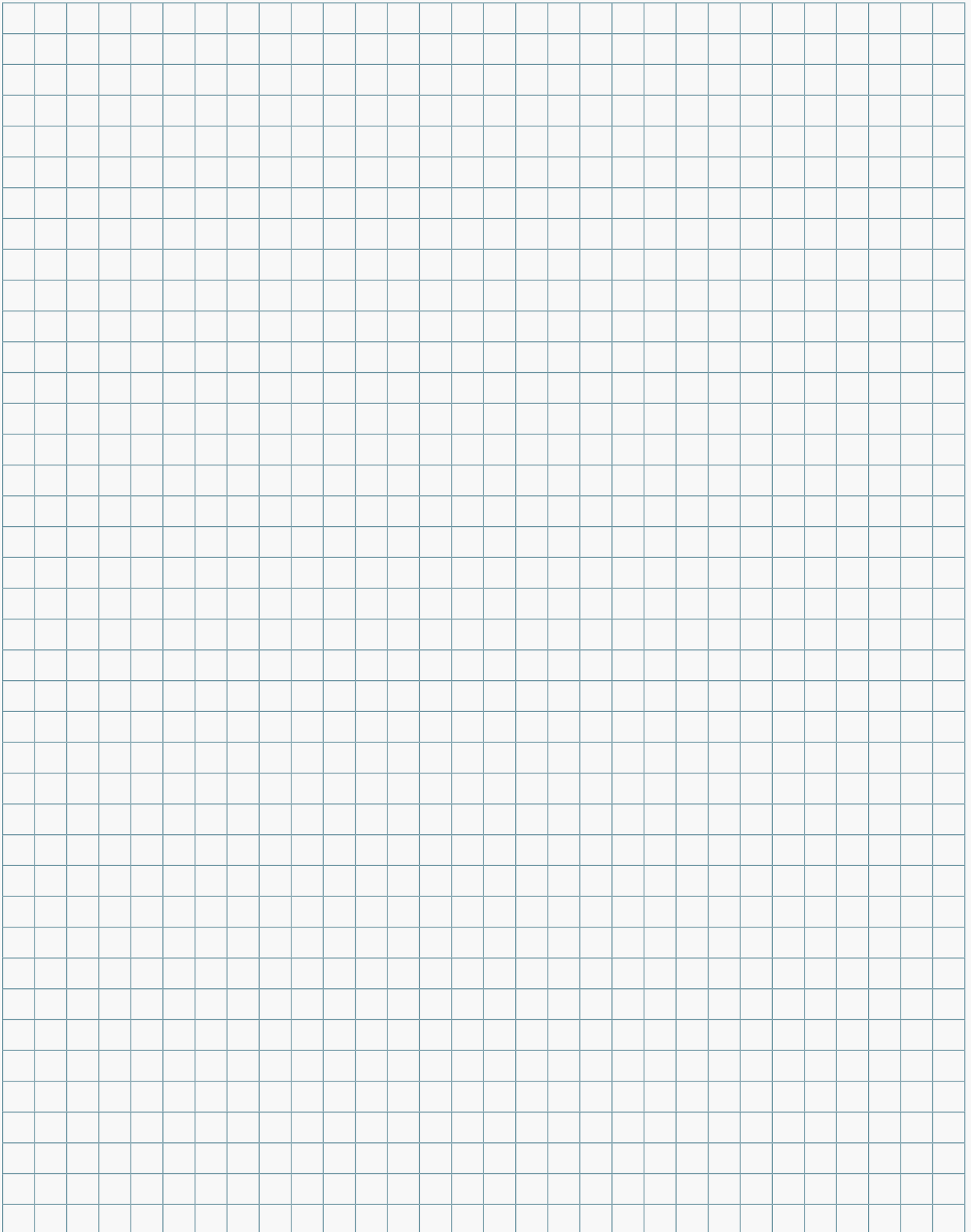

Adelmann GmbH
Wilhelm-Leonhard-Straße 5 | 77694 Kehl-Goldscheuer | Germany

